

**E** **INSTRUCCIONES DE MONTAJE.**  
ADVERTENCIA: Para evitar cualquier riesgo de vuelco, este mueble debe fijarse a la pared utilizando los medios de sujeción adecuados al soporte.

**EN** **INSTALLATION INSTRUCTIONS.**  
WARNING: To avoid any risk of tipping over, this furniture must be fixed to the wall using the appropriate fixing system.

**D** **MONTAGEANLEITUNG.** WARNUNG: Um die Gefahr des Umkippen zu vermeiden, müssen diese Möbel mit den entsprechenden Befestigungsmitteln am Träger und der Wand befestigt werden.

**FR** **INSTRUCTIONS DE MONTAGE.**  
AVERTISSEMENT : Pour éviter tout risque de basculement, ce meuble doit être fixé au mur en utilisant des moyens de fixations adaptés au support.

**P** **INSTRUÇÕES DE MONTAGEM.**  
AVISO: Para evitar qualquer risco de tombamento, esse móvel deve ser fixado na parede usando os meios de fixação adequados ao suporte.

**I** **ISTRUZIONI DI MONTAGGIO.**  
ATTENZIONE: per evitare qualsiasi rischio di ribaltamento, questo mobile deve essere fissato al muro utilizzando dispositivi di fissaggio adeguati al supporto.

**Salgar**  
MANY PLACES, MANY BATHROOMS

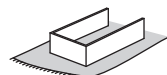

1

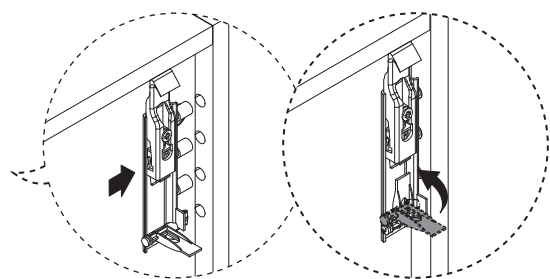
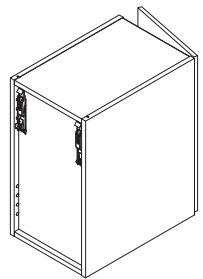
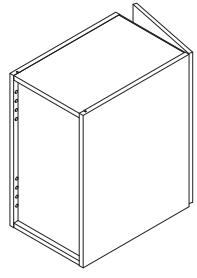
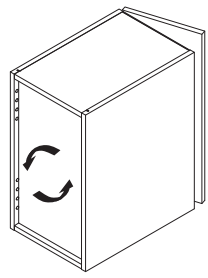
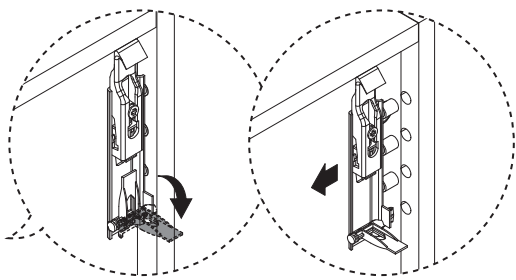
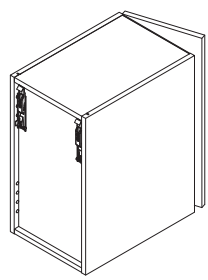
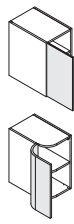

2

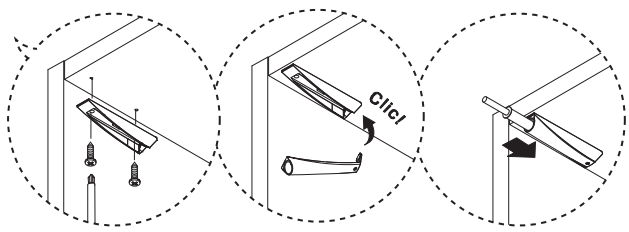
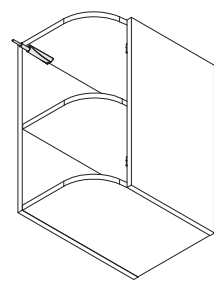
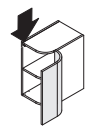
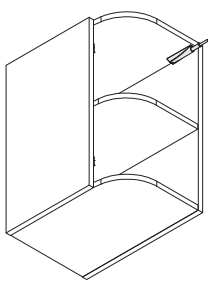
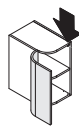

3

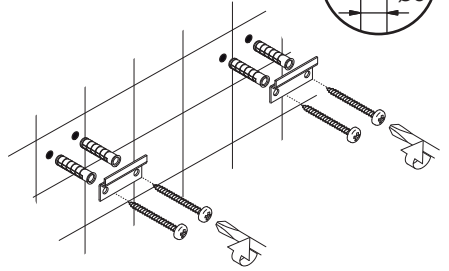
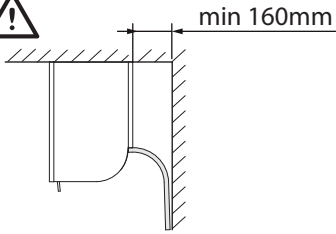
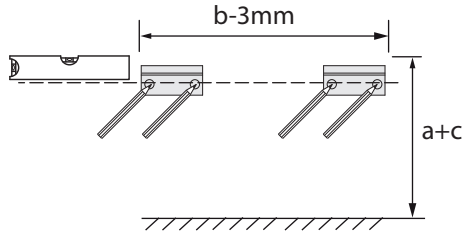
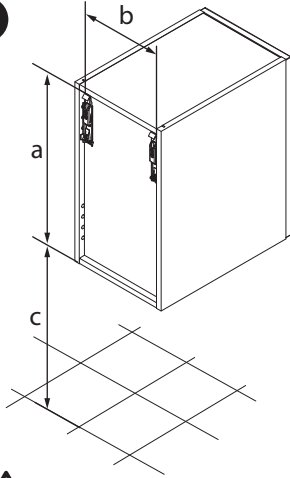

4

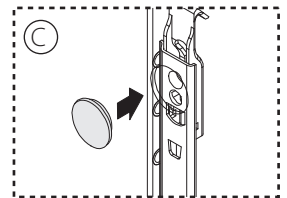
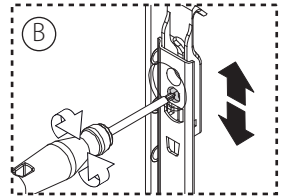
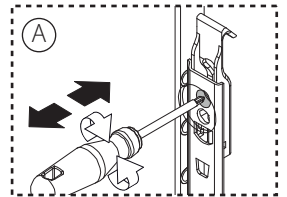
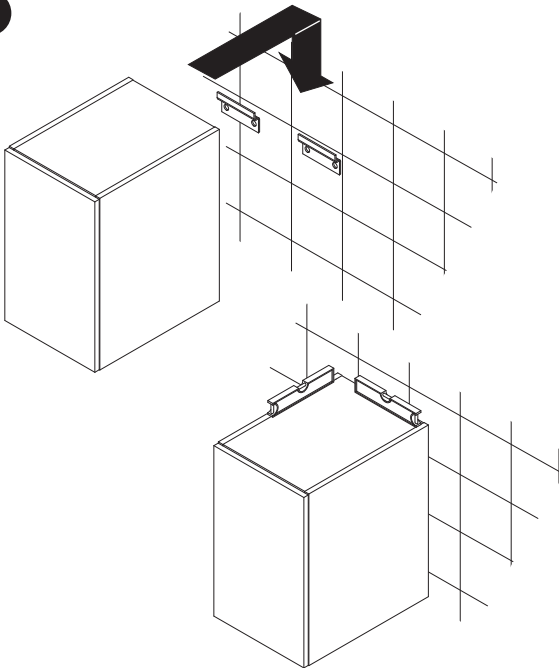

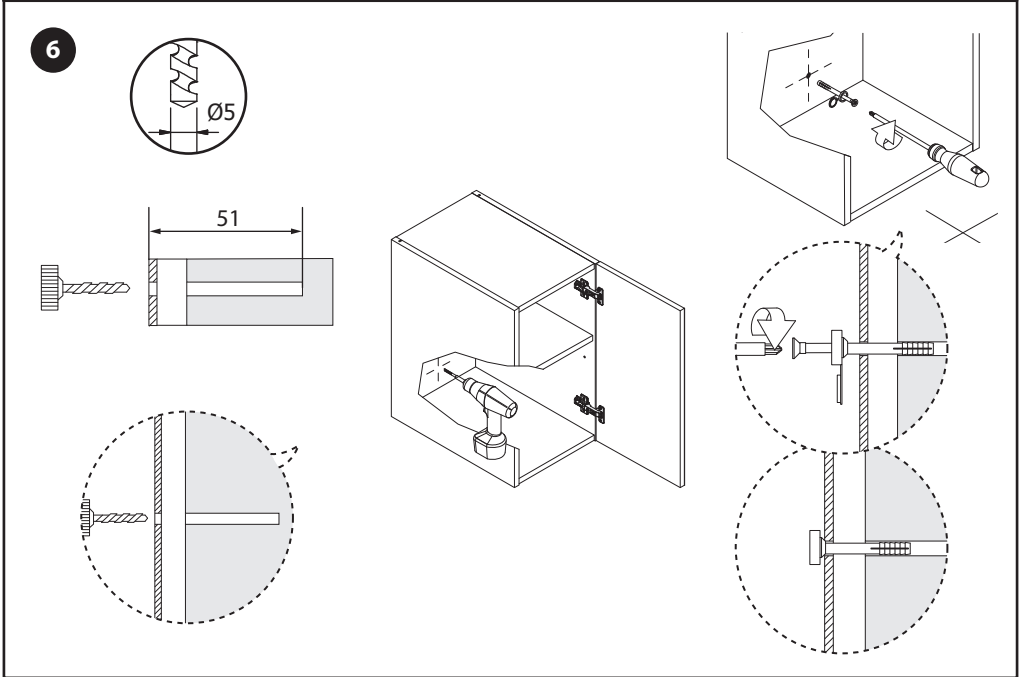
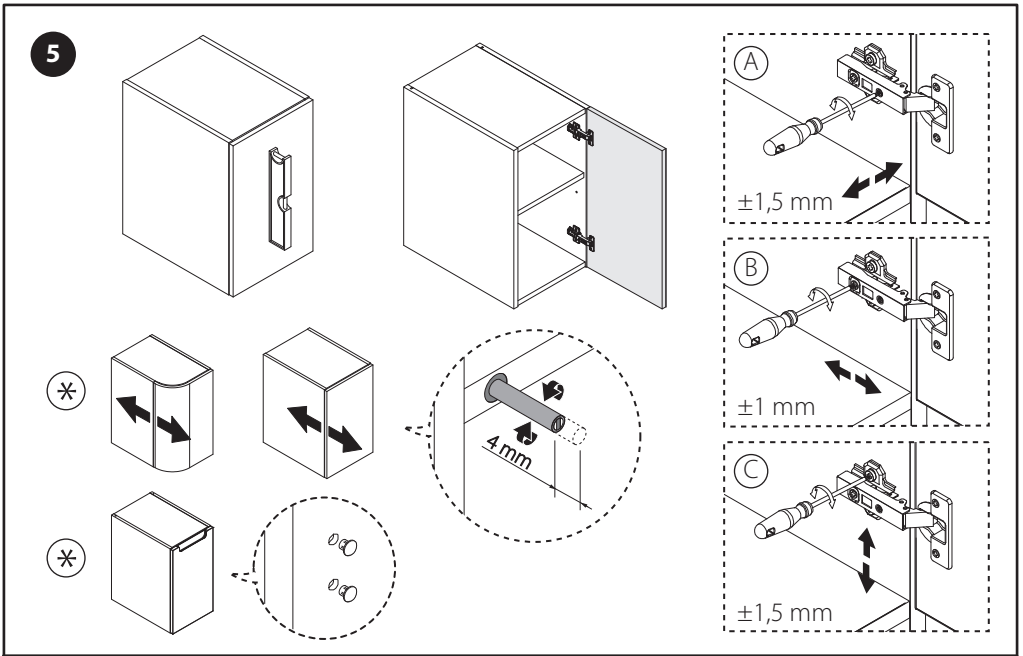

FR  
Pensez à  
donner ou recycler.



Association

ou



Magasin

ou



Déchèterie

<https://quefairedemesdechets.fr>



99932- 20230525