

VID03

MAMPARA DE DUCHA

SERIE:	VID
FUNCIONALIDAD:	CORREDERA
POSICIÓN:	ANGULAR
COMPOSICIÓN:	2 HOJAS CORREDERAS + 2 FIJOS

CE
EN 14428

CE
EN 12150

- es** **MANUAL DE INSTRUCCIONES**
No tirar. Guardar para uso posterior
- en** **INSTRUCTION MANUAL**
Do not discard. Keep for future use.
- fr** **MANUEL D'INSTRUCTIONS**
Ne pas jeter. Conserver pour une utilisation ultérieure.
- pt** **MANUAL DE INSTRUÇÕES**
Não descarte. Guarde para uso futuro.
- it** **MANUALE DI ISTRUZIONI**
Non gettare. Conservare per uso futuro.

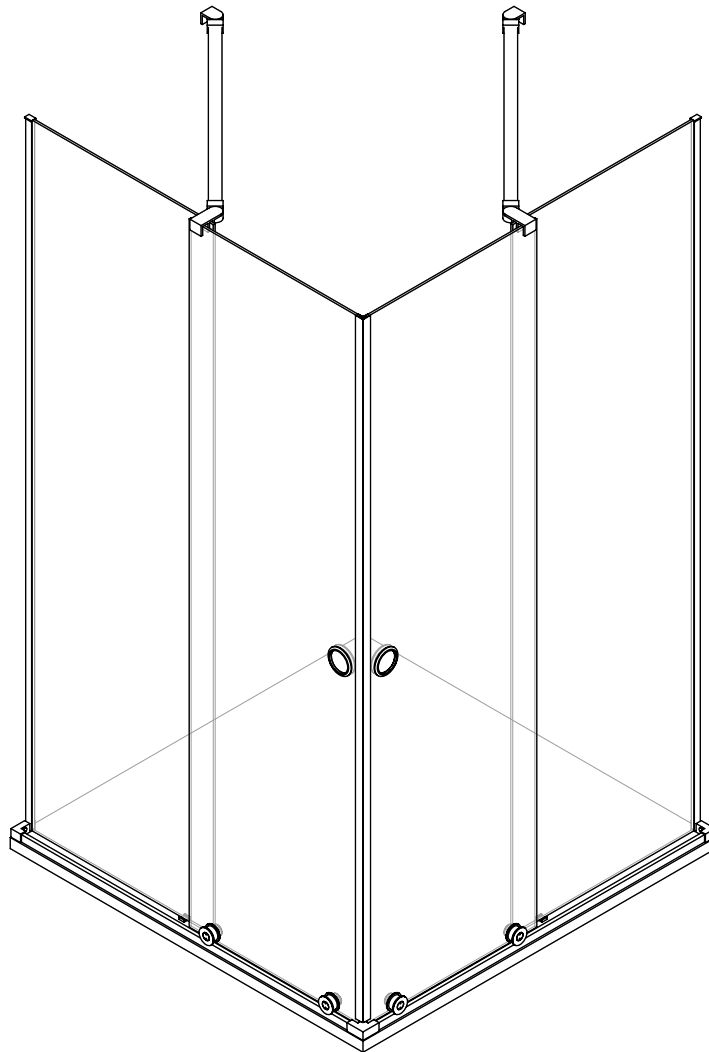

es GARANTÍAS

La mercancía está garantizada conforme a la normativa europea Directiva 2019/771. Esta garantía cubre un periodo de **10 AÑOS** a partir de la fecha de factura del producto. Únicamente se considerarán válidas las reclamaciones realizadas por escrito.

La garantía no cubre deterioros que no sean imputables al producto, ni aquellos que resulten de deficiencias en el montaje y la instalación, o de negligencia en su manipulación.

GLASSINOX S.L. asume la garantía de sus productos, entendiéndolo y acordando expresamente que esta garantía se limita a la sustitución de los productos defectuosos por otros de características similares, excluyendo cualquier otra compensación, incluso por daños o intereses.

en WARRANTIES

The merchandise is guaranteed in accordance with the European regulation Directive 2019/771. This warranty covers a period of **10 YEARS** from the date of the product invoice. Only claims made in writing will be considered valid.

The warranty does not cover damages not attributable to the product, nor those resulting from deficiencies in assembly and installation, or from negligence in handling.

GLASSINOX S.L. assumes the warranty for its products, with the understanding and express agreement that this warranty is limited to the replacement of defective products with others of similar characteristics, excluding any other compensation, including damages or interest.

fr GARANTIES

La marchandise est garantie conformément à la réglementation européenne Directive 2019/771. Cette garantie couvre une période de **10 ANS** à partir de la date de la facture du produit. Seules les réclamations effectuées par écrit seront considérées comme valides.

La garantie ne couvre pas les détériorations non imputables au produit, ni celles résultant de défaillances dans le montage et l'installation, ou de négligence dans la manipulation.

GLASSINOX S.L. assume la garantie de ses produits, avec la compréhension et l'accord exprès que cette garantie se limite au remplacement des produits défectueux par d'autres de caractéristiques similaires, à l'exclusion de toute autre compensation, y compris pour dommages ou intérêts.

pt GARANTIAS

A mercadoria está garantida de acordo com a regulamentação europeia Diretiva 2019/771. Esta garantia cobre um período de **10 ANOS** a partir da data da fatura do produto. Apenas as reclamações feitas por escrito serão consideradas válidas.

A garantia não cobre danos não imputáveis ao produto, nem aqueles resultantes de deficiências na montagem e instalação, ou de negligência na manipulação.

GLASSINOX S.L. assume a garantia de seus produtos, entendendo e concordando expressamente que esta garantia se limita à substituição dos produtos defeituosos por outros de características similares, excluindo qualquer outra compensação, incluindo danos ou juros.

it GARANZIE

La merce è garantita conformemente alla normativa europea Direttiva 2019/771. Questa garanzia copre un periodo di **10 ANNI** a partire dalla data della fattura del prodotto. Solo le reclami effettuate per iscritto saranno considerate valide.

La garanzia non copre i danni non imputabili al prodotto, né quelli derivanti da difetti nel montaggio e nell'installazione, o da negligenza nella manipolazione.

GLASSINOX S.L. si assume la garanzia dei suoi prodotti, con la comprensione e l'accordo esplicito che tale garanzia è limitata alla sostituzione dei prodotti difettosi con altri di caratteristiche simili, escludendo qualsiasi altra compensazione, inclusi danni o interessi.

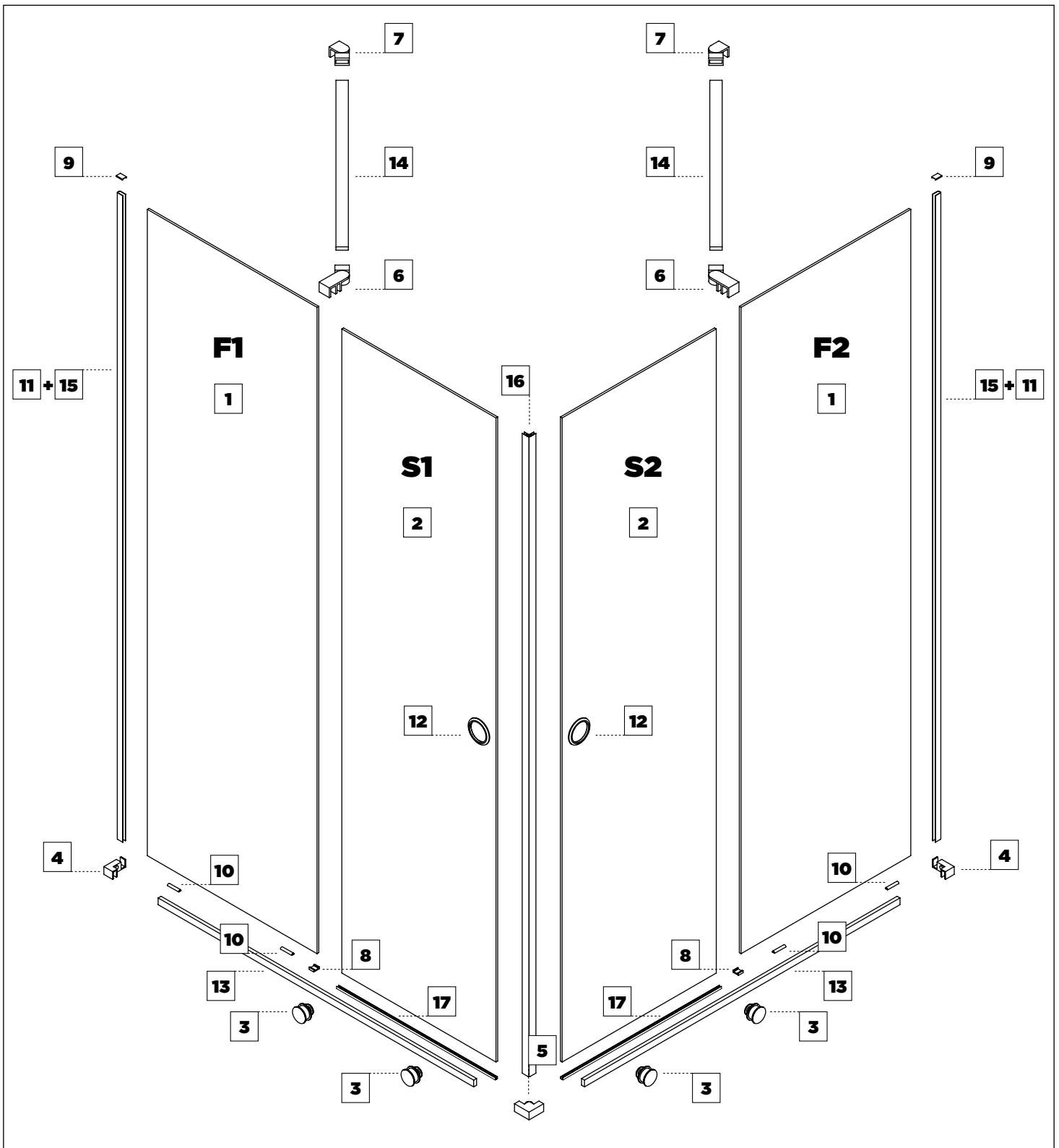

es ADVERTENCIA **en WARNING** **fr AVERTISSEMENT** **pt AVISO** **it AVVERTENZA**

Realizar el montaje siguiendo las instrucciones del fabricante, en caso contrario, puede haber riesgo de seguridad por caída, vuelco o rotura, que pueden provocar lesiones graves.

- Durante el montaje o desmontaje, llevar gafas y guantes de seguridad.
- Durante el montaje, repose el cristal sobre superficie de protección y a resguardo de ser golpeado.
- No apoyar objetos pesados sobre el producto.
- Evite que los niños se apoyen, golpeen o cuelguen de la mampara de ducha.
- Evite realizar actividades inapropiadas en las inmediaciones de la mampara.

Es un cristal templado de seguridad, diseñado para romper en pequeñas piezas no punzantes, evitando daños mayores.

The screen assembly must be carried out following the manufacturer's instructions; otherwise, there may be a safety risk due to falling, tipping, or breakage, which can cause serious injuries.

- During assembly or disassembly, wear safety glasses and gloves.
- During assembly, rest the glass on a protective surface and keep it safe from impacts.
- Do not place heavy objects on the product.
- Prevent children from leaning on, hitting, or hanging from the shower screen.
- Avoid inappropriate activities near the screen.

It is a tempered safety glass, designed to break into small, non-sharp pieces to prevent major injuries.

Le montage de la paroi doit être effectué en suivant les instructions du fabricant, sinon il peut y avoir un risque de sécurité en raison de chutes, de renversements ou de ruptures, pouvant provoquer des blessures graves.

- Lors du montage ou du démontage, portez des lunettes et des gants de sécurité.
- Pendant le montage, reposez le verre sur une surface de protection et à l'abri des impacts.
- Ne placez pas d'objets lourds sur le produit.
- Empêchez les enfants de s'appuyer, de frapper ou de se suspendre à la paroi de douche.
- Évitez les activités inappropriées à proximité de la paroi.

Il s'agit d'un verre de sécurité trempé, conçu pour se casser en petits morceaux non tranchants afin d'éviter des blessures graves.

A montagem do box deve ser realizada seguindo as instruções do fabricante; caso contrário, pode haver risco de segurança devido a quedas, tombamentos ou quebras, que podem causar lesões graves.

- Durante a montagem ou desmontagem, use óculos e luvas de segurança.
- Durante a montagem, coloque o vidro sobre uma superfície de proteção e mantenha-o protegido contra impactos.
- Não coloque objetos pesados sobre o produto.
- Evite que as crianças se apoiem, batam ou se pendurem no box de banho.
- Evite atividades inadequadas nas proximidades do box.











É um vidro temperado de segurança, projetado para quebrar em pequenos pedaços não pontiagudos, evitando maiores danos.

Il montaggio del box doccia deve essere eseguito seguendo le istruzioni del produttore; in caso contrario, potrebbe esserci un rischio di sicurezza dovuto a cadute, ribaltamenti o rotture, che possono causare lesioni gravi.

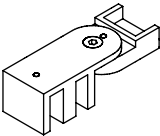
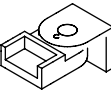



- Durante il montaggio o lo smontaggio, indossate occhiali e guanti di sicurezza.
- Durante il montaggio, posizionare il vetro su una superficie protettiva e al riparo da urti.
- Non appoggiare oggetti pesanti sul prodotto.
- Evitare che i bambini si appoggino, colpiscano o si appendano al box doccia.
- Evitare attività inappropriate nelle vicinanze del box doccia.

È un vetro temperato di sicurezza, progettato per rompersi in piccoli pezzi non appuntiti, evitando lesioni gravi.

es PIEZAS en PIECES fr PIÈCES pt PEÇAS it PEZZI

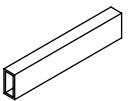
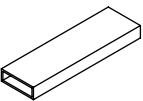
					
1 1x 0-00001	3 4x 02010020	4 2x 02010111	5 1x 02010116	6 2x 02010117	7 2x 02010065
					
2 1x 0-00002	8 2x 02010114	9 2x 02010134	10 4x 02020044	11 2x 02020042	12 2x 02010020

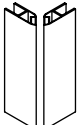
es PERFILES en PROFILES fr PROFILS pt PERFIS it PROFILI

				
13 2x 02030065	14 2x 02030075	15 2x 02030021	16 1x 02020001	17 2x 02020016

es HERR.
en HARDWARE
fr FERR.
pt FERRAGENS
it FERRA.



3x32 mm



5x30 mm

A 6x 02040050

B 6x 02040044

es OTROS
en OTHERS
fr AUTRES
pt OUTROS
it ALTRI

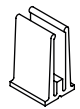

1a 4x

es HERRAMIENTAS en TOOLS fr OUTILS pt FERRAMENTAS it STRUMENTI

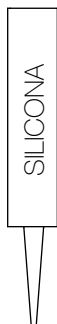
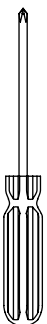

SILICONA

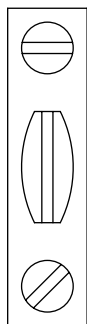

Ø5

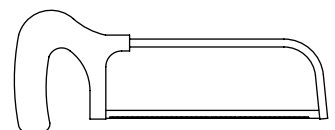
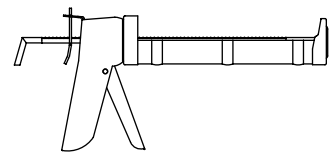
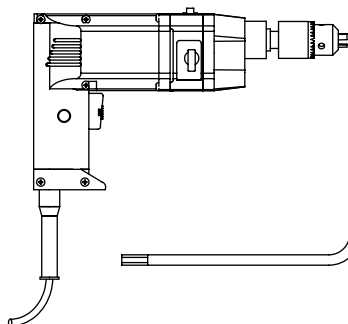

1

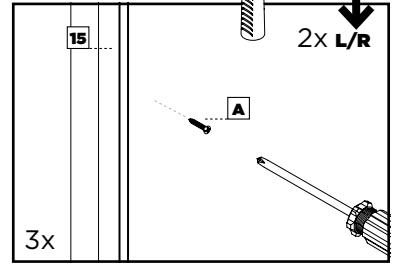
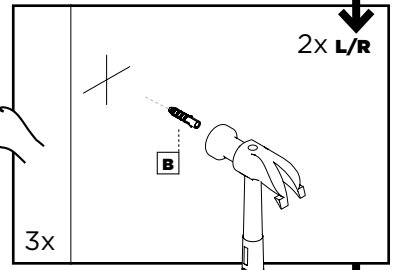
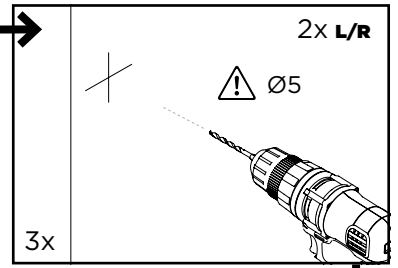
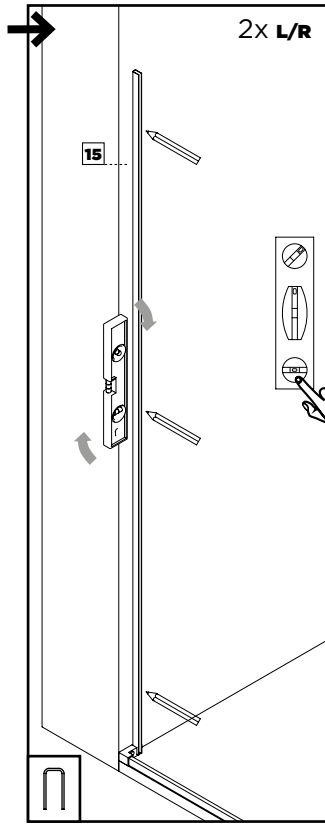
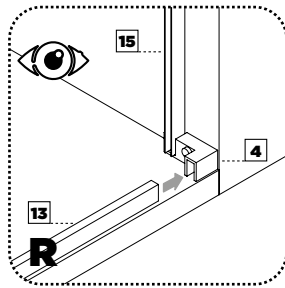
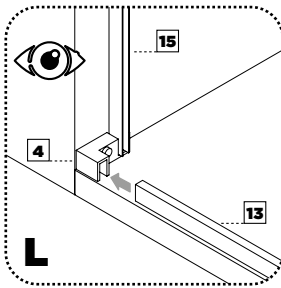
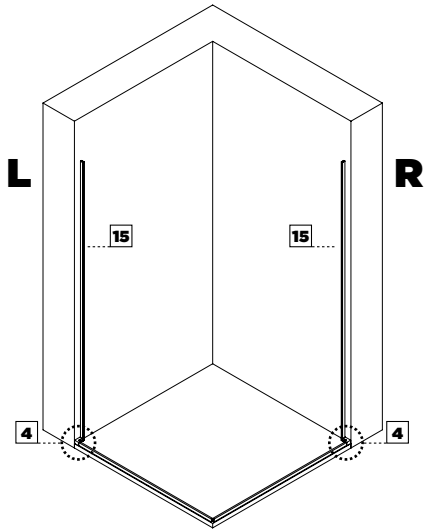
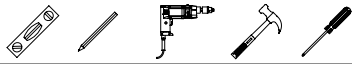

2

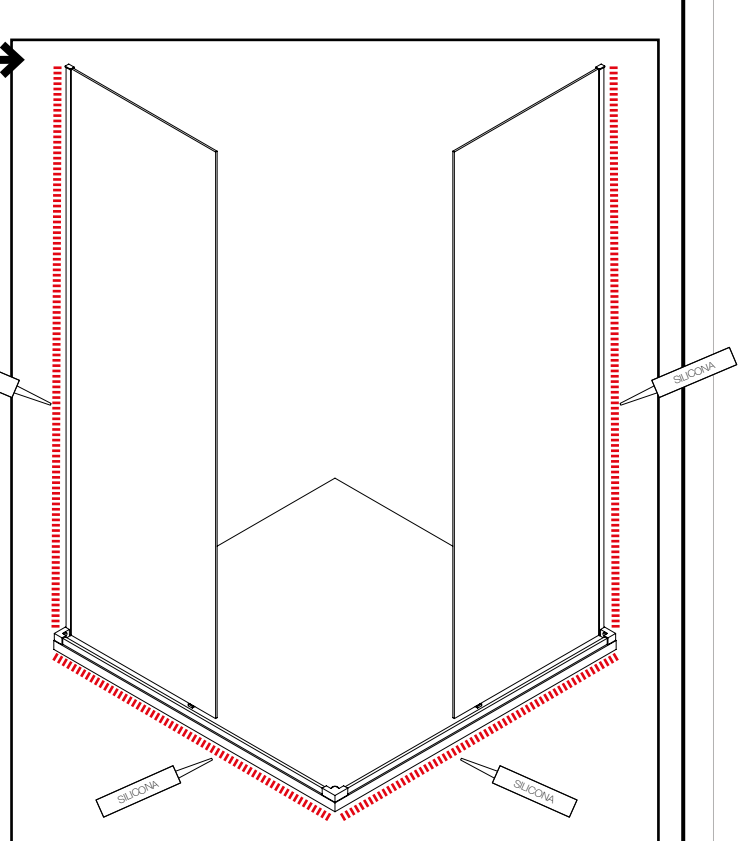
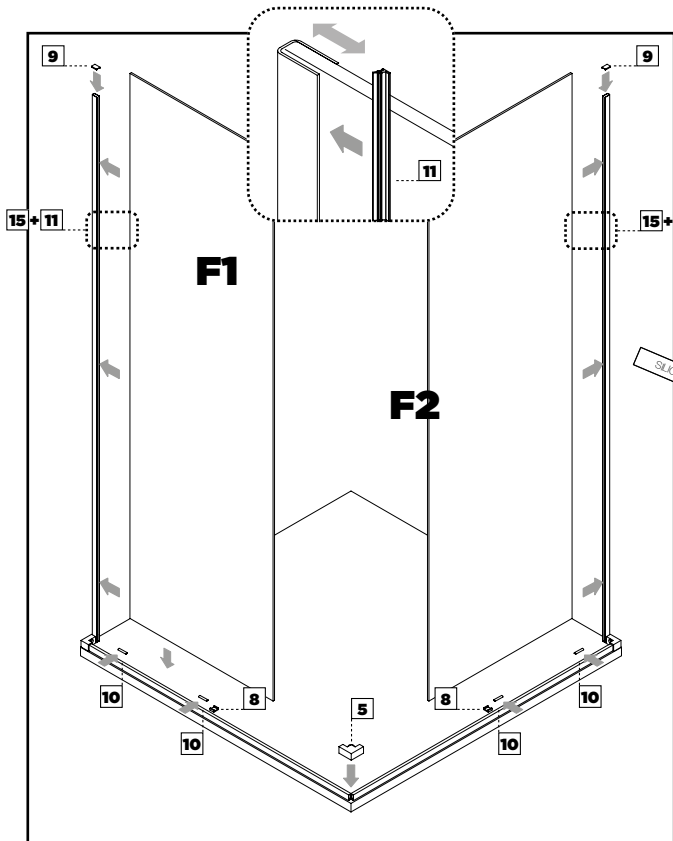

3



16



17



6

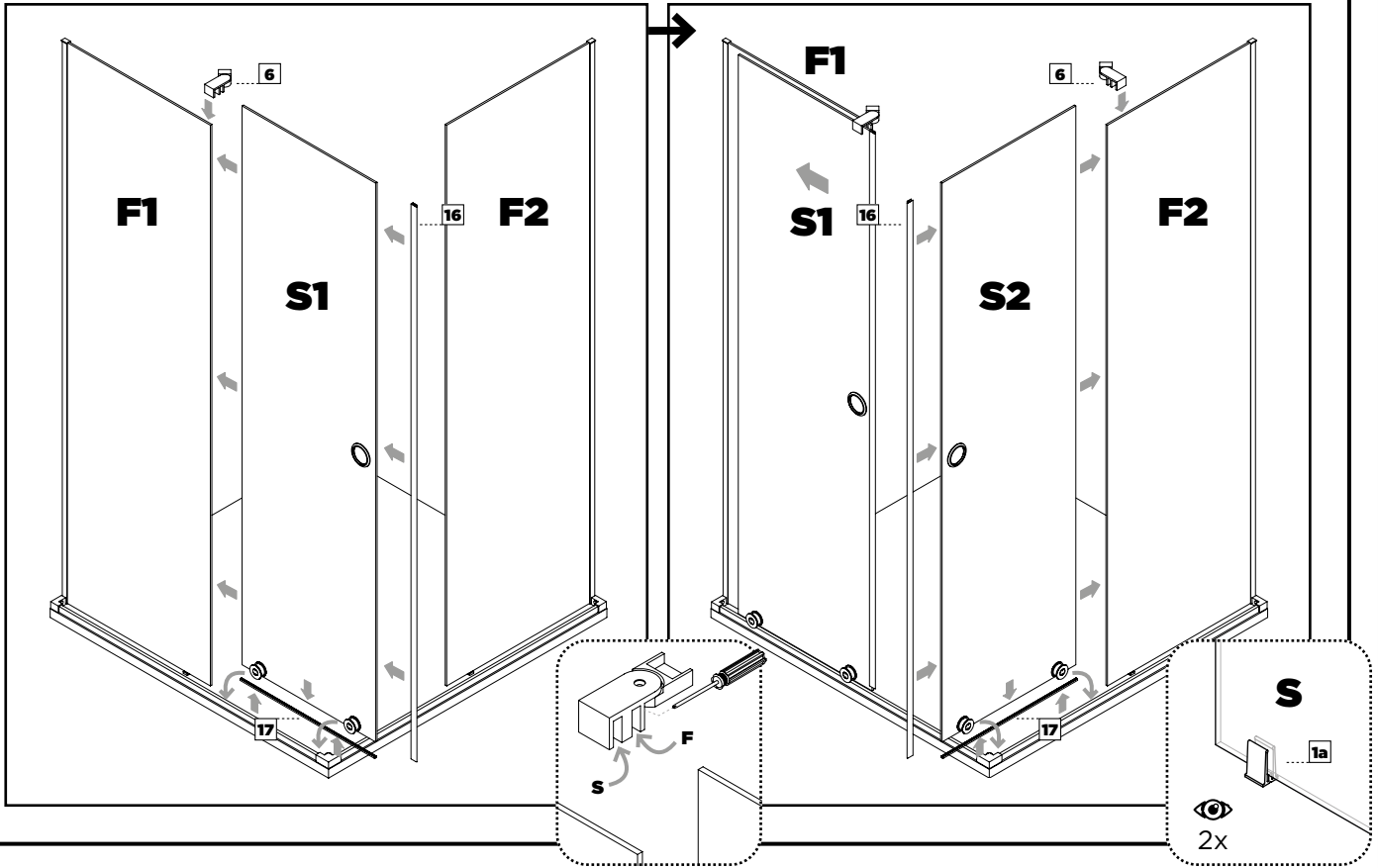

4



14



7

